



DSH*

LEVER OPERATED DIRECTIONAL CONTROL VALVE

MOUNTING SURFACES

DSH3 ISO 4401-03 (CETOP 03)

DSH5 ISO 4401-05 (CETOP R05)

p max (see performances table)

Q nom (see performances table)

OPERATING PRINCIPLE

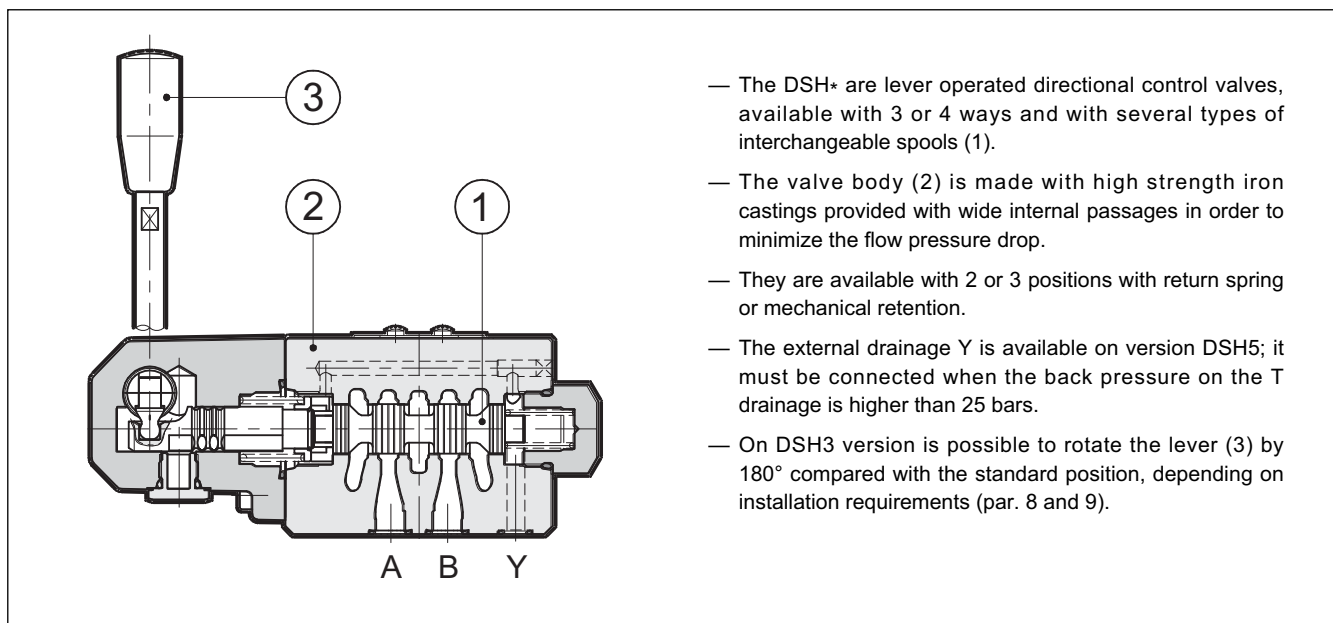











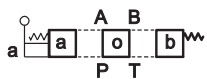



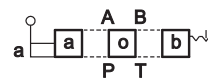





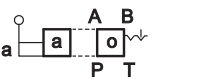

PERFORMANCES (with mineral oil of viscosity of 36 cSt at 50°C)

		DSH3	DSH5
Maximum working pressure:	- P - A - B ports	350	320
	- T port	210	25
	- T port with Y external drain usage (only for DSH5)		320
Nominal flow rate	l/min	75	150
Ambient temperature range	°C	-20 / +50	
Fluid temperature range	°C	-20 / +80	
Fluid viscosity range	cSt	10 + 400	
Fluid contamination degree		according to ISO 4406:1999 class 20/18/15	
Recommended viscosity	cSt	25	
Mass	kg	2.1	4.2

1 - IDENTIFICATION CODE

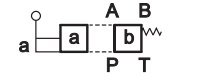
	<div style="display: flex; justify-content: space-around; align-items: center;"> <div style="border: 1px solid black; padding: 2px 5px;">D</div> <div style="border: 1px solid black; padding: 2px 5px;">S</div> <div style="border: 1px solid black; padding: 2px 5px;">H</div> <div style="border: 1px solid black; padding: 2px 5px;"> </div> <div style="border: 1px solid black; padding: 2px 5px;">-</div> <div style="border: 1px solid black; padding: 2px 5px;">/</div> <div style="border: 1px solid black; padding: 2px 5px;"> </div> <div style="border: 1px solid black; padding: 2px 5px;"> </div> </div>	
Directional control valve with spool		Seals: N = NBR seals for mineral oil (standard) V = FPM seals for special fluids
Lever operated		Series No.: 11 for DSH3 (the overall and mounting dimensions remain unchanged from 10 to 19) 20 for DSH5 (the overall and mounting dimensions remain unchanged from 20 to 29)
Size: 3 = ISO 4401-03 (CETOP 03) 5 = ISO 4401-05 (CETOP R05)		Spool type (see par. 4) S* SK* SA* SAK* TA TAK TA23 TAK23
NOTE: On request it is possible to have the lever mounted in different positions from those in the catalogue. Consult our Technical Department.		

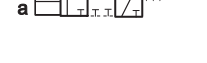
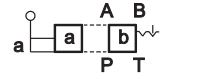
2 - SPOOL TYPE

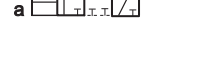
<p>Type S*: 3 positions with spring centering</p>  <p>S1 </p> <p>S2 </p> <p>S3 </p> <p>S4 </p>	<p>Type SK*: 3 positions with mechanical retention</p>  <p>SK1 </p> <p>SK2 </p> <p>SK3 </p> <p>SK4 </p>	<p>Type SA*: 2 positions (central + external) with spring centering</p>  <p>SA1 </p> <p>SA2 </p> <p>SA3 </p> <p>SA4 </p>	<p>Type SAK*: 2 positions (central + external) with mechanical retention</p>  <p>SAK1 </p> <p>SAK2 </p> <p>SAK3 </p> <p>SAK4 </p>
<p>Type TA: 2 external positions with return spring</p>  <p>TA </p> <p>TA02 </p> <p>TA23 </p>	<p>Type TAK: 2 external positions with mechanical retention</p>  <p>TAK </p> <p>TAK02 </p> <p>TAK23 </p>	<p>Besides the diagrams shown, which are the most frequently used, other special versions are available: consult our Technical Department for their identification and operating limits.</p>	

3 - HYDRAULIC FLUIDS

Use mineral oil-based hydraulic fluids HL or HM type, according to ISO 6743-4. For these fluids, use NBR seals (code N). For fluids HFDR type (phosphate esters) use FPM seals (code V). For the use of other fluid types such as HFA, HFB, HFC, please consult our technical department.

Using fluids at temperatures higher than 80 °C causes a faster degradation of the fluid and of the seals characteristics. The fluid must be preserved in its physical and chemical characteristics.

4 - PRESSURE DROPS Δp -Q (values obtained with viscosity 36 cSt at 50 °C)

4.1 - DSH3

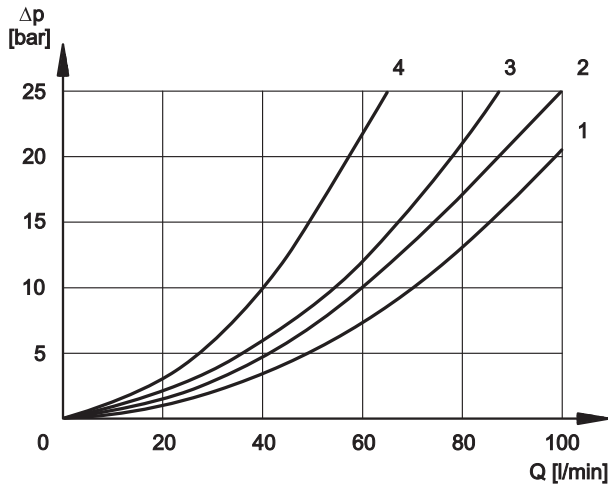

VALVE IN ENERGIZED POSITION

SPOOL TYPE	FLOW DIRECTION			
	P→A	P→B	A→T	B→T
	CURVES ON GRAPH			
S1, SA1, SAK1	2	2	3	3
S2, SA2, SAK2	1	1	3	3
S3, SA3, SAK3	3	3	1	1
S4, SA4, SAK4	4	4	4	4
TA, TAK	3	3	3	3
TA02, TAK02	2	2	2	2
TA23, TAK23	3	3		

VALVE IN DE-ENERGIZED POSITION

SPOOL TYPE	FLOW DIRECTION				
	P→A	P→B	A→T	B→T	P→T
	CURVES ON GRAPH				
S2, SA2, SAK2					2
S3, SA3, SAK3			3	3	
S4, SA4, SAK4					3

4.2 - DSH5

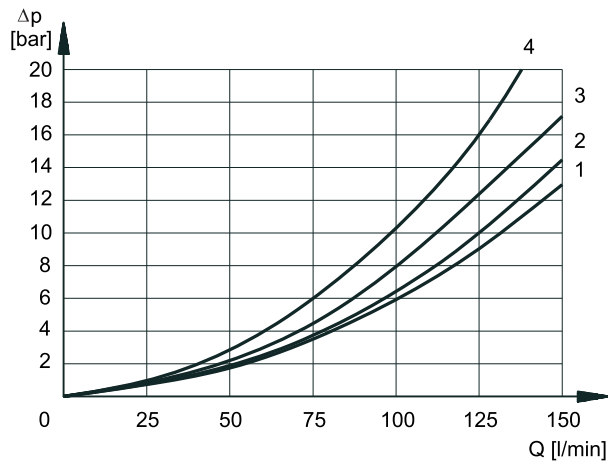

VALVE IN ENERGIZED POSITION

SPOOL TYPE	FLOW DIRECTION			
	P→A	P→B	A→T	B→T
	CURVES ON GRAPH			
S1, SK1	2	2	1	1
S2, SK2	3	3	1	1
S3, SK3	3	3	2	2
S4, SK4	1	1	2	2
TA, TAK	3	3	2	2

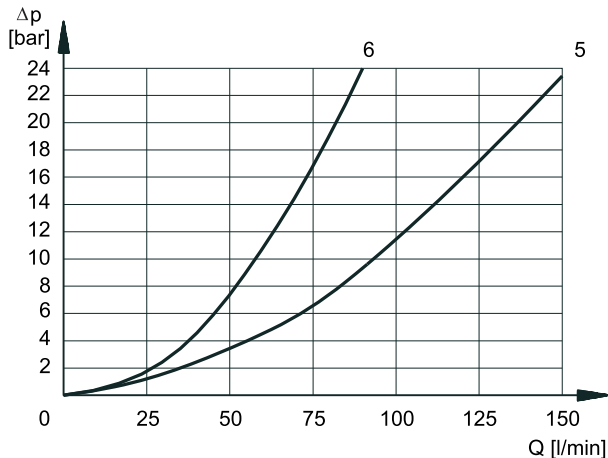

VALVE IN DE-ENERGIZED POSITION

SPOOL TYPE	FLOW DIRECTION				
	P→A	P→B	A→T	B→T	P→T
	CURVES ON GRAPH				
S2, SK2					5
S3, SK3			6	6	
S4, SK4					5

5 - OPERATING LIMITS

The curves define the flow rate operating fields according to the valve pressure of the different versions.

The values have been obtained according to ISO 6403 norm, with mineral oil viscosity 36 cSt at 50 °C and filtration ISO 4406:1999 class 18/16/13.

5.1 - DSH3

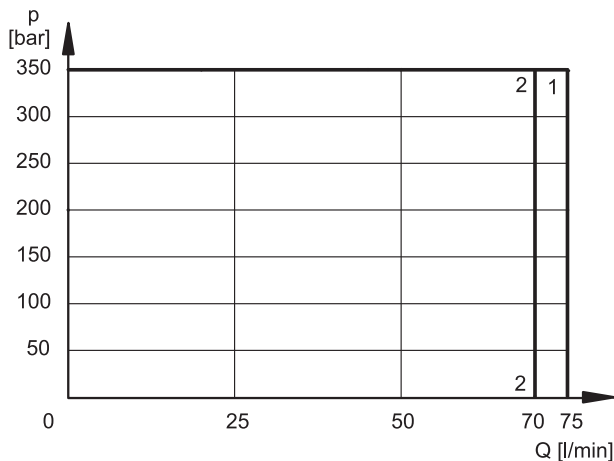

SPOOL TYPE	CURVE	
	P→A	P→B
S1, SK1, SA1, SAK1	1	1
S2, SK2, SA2, SAK2	1	1
S3, SK3, SA3, SAK3	1	1
S4, SK4, SA4, SAK4	2	2

SPOOL TYPE	CURVE	
	P→A	P→B
TA, TAK	1	1
TA02, TAK02	1	1
TA23, TAK23	1	1

5.2 - DSH5

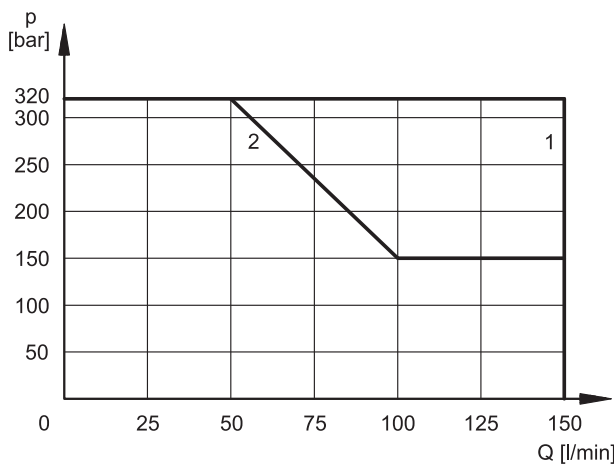

SPOOL TYPE	CURVE	
	P→A	P→B
S1, SK1, SA1, SAK1	1	1
S2, SK2, SA2, SAK2	1	1
S3, SK3, SA3, SAK3	1	1
S4, SK4, SA4, SAK4	2	2

SPOOL TYPE	CURVE	
	P→A	P→B
TA, TAK	1	1

NOTE: Values in the graphs are relevant to the standard valve. The operating limits can be considerably reduced if a 4-way valve is used with port A or B plugged.

6 - INSTALLATION

Configurations with centering and return springs can be mounted in any position; valves with mechanical detent must be mounted with the longitudinal axis horizontal.

Valve fixing is by means of screws or tie rods, with the valve mounted on a lapped surface, with values of planarity and smoothness that are equal to or better than those indicated in the drawing. If the minimum values of planarity and/or smoothness are not met, fluid leakage between valve and mounting surface can easily occur.

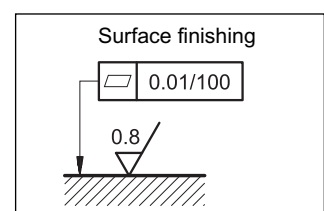

7 - OVERALL AND MOUNTING DIMENSIONS DSH3

DSH3 - S*
DSH3 - SK*

dimensions in mm

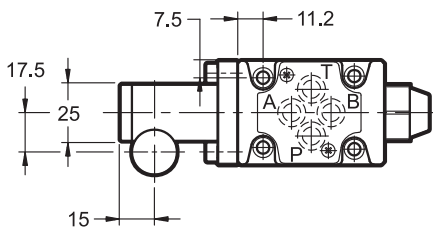
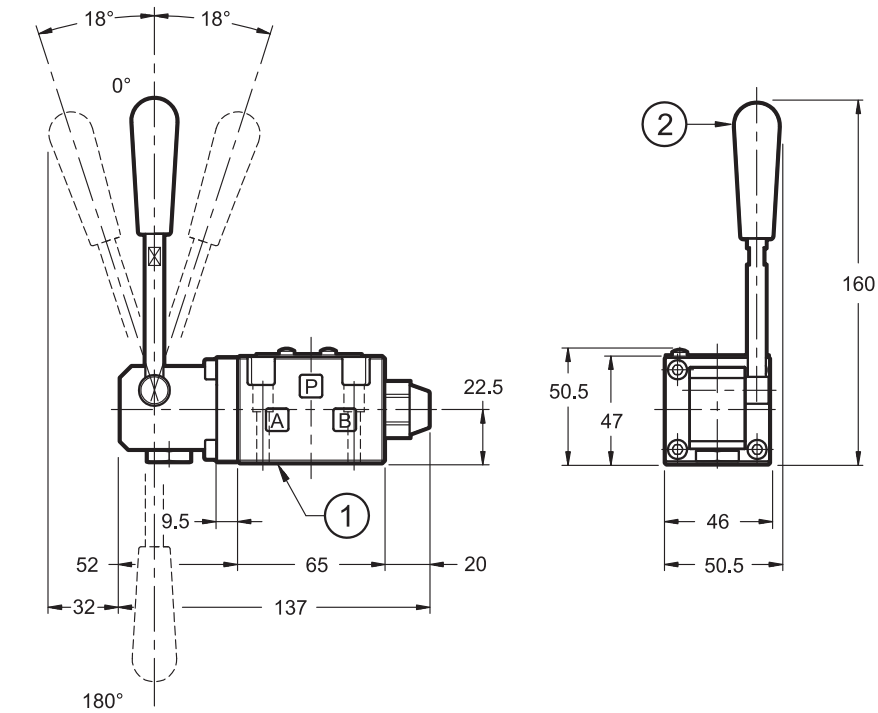

DSH3-TA
DSH3-TAK

DSH3-TA23
DSH3-TAK23

DSH3-SA*
DSH3-SAK*

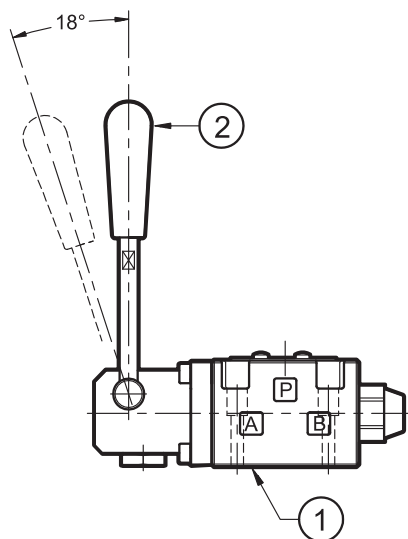

DSH3 MOUNTING SURFACE

ISO 4401-03-02-0-05
(CETOP 4.2-4-03-350)

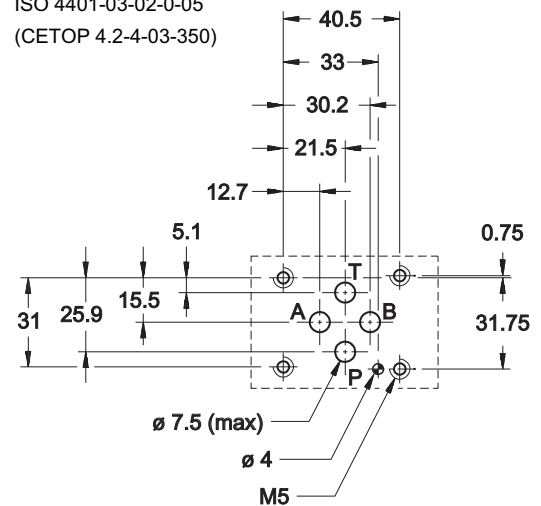

1	Mounting surface with sealing rings: N. 4 OR type 2037 (9.25x1.78) - 90 Shore
2	Hand lever (NOTE)

Valve fastening:	N. 4 SHC screws M5x30 ISO 4762
Tightening torque:	5 Nm (bolts A 8.8)
Threads of mounting holes:	M5x10

NOTE: The valve is supplied with the hand lever oriented in a perpendicular position with respect to the mounting surface (as indicated in the above drawing). For installation needs the hand lever can be oriented by the user directly at 180° to the standard position, simply by unscrewing the lever and re-screwing it in the desired position.

8 - OVERALL AND MOUNTING DIMENSIONS DSH5

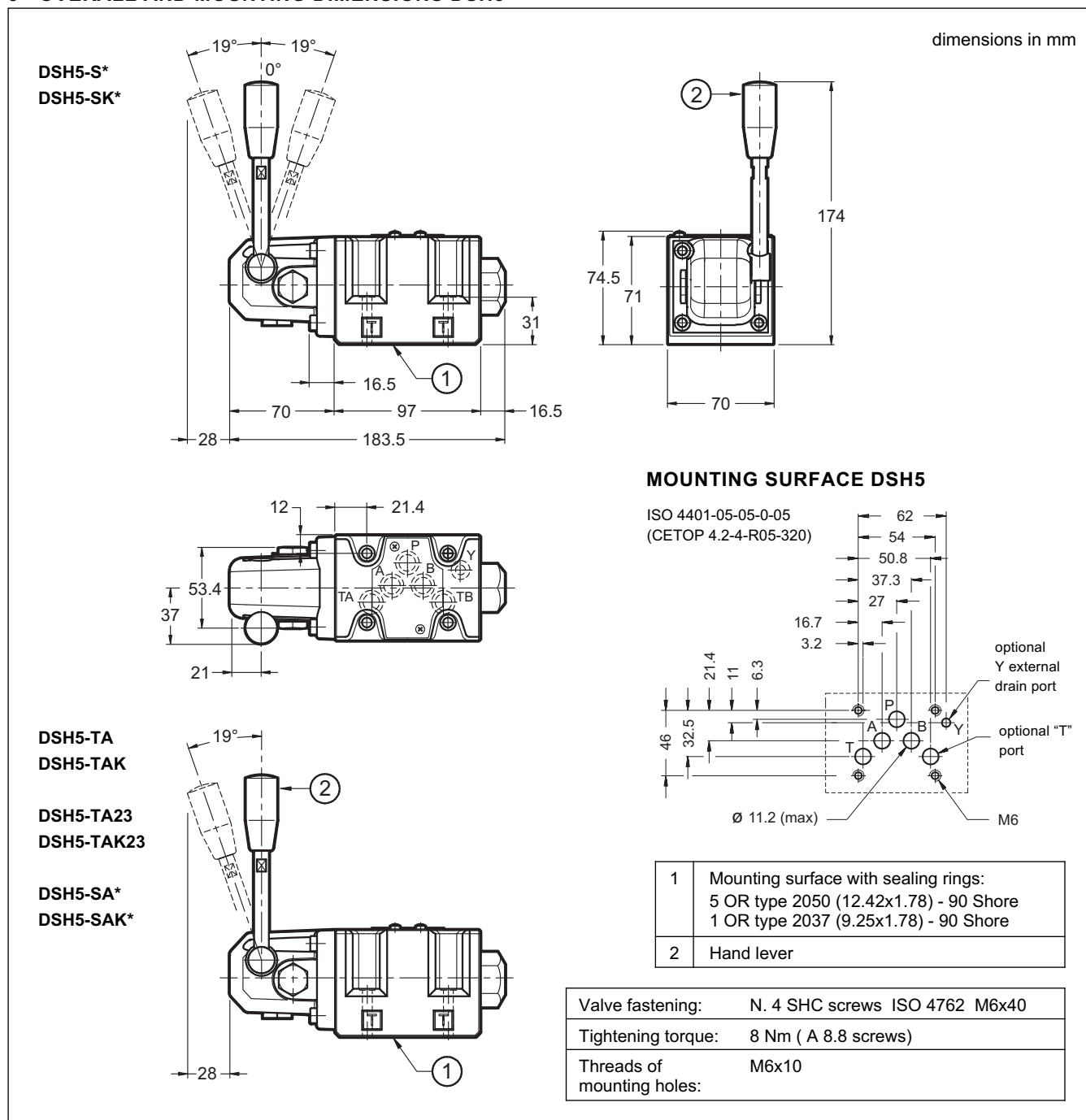

9 - SUBPLATES (See catalogue 51 000)

	DSH3	DSH5
Type with rear ports	PMMD-AI3G	PMD4-AI4G - 3/4" BSP threaded
Type with side ports	PMMD-AL3G	PMD4-AL4G - 1/2" BSP threaded
P, T, A and B threads	3/8" BSP	



DIPLOMATICO OLEODINAMICA S.p.A.
 20015 PARABIAGO (MI) • Via M. Re Depaolini 24
 Tel. +39 0331.895.111
 Fax +39 0331.895.339
 www.diplomatic.com • e-mail: sales.exp@diplomatic.com