

DSE5G

DIRECTIONAL VALVE WITH PROPORTIONAL CONTROL AND INTEGRATED ELECTRONICS

SERIES 10

SUBPLATE MOUNTING
ISO 4401-05 (CETOP 05)

p max **320** bar
Q max **90** l/min

MOUNTING SURFACE

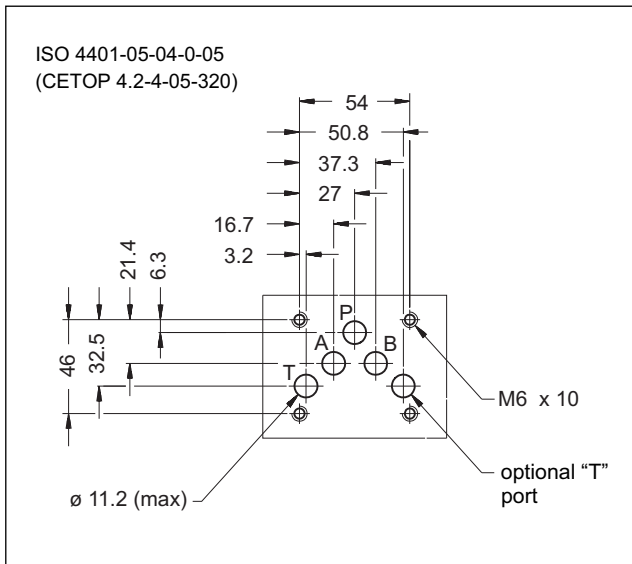

OPERATING PRINCIPLE

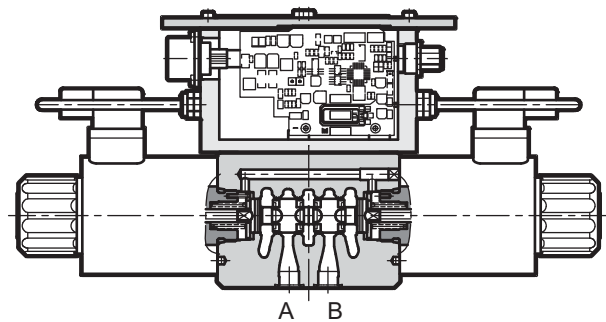

— The DSE5G is a direct operated directional valve with integrated electric proportional control and mounting interface in compliance with ISO 4401 (CETOP RP 121H) standards.

— It is normally used to control the positioning and the speed of hydraulic actuators.

— The valve opening and hence flow rate can be modulated continuously in proportion to the reference signal.

— The valve is controlled directly by an integrated digital amplifier (see par. 5).

PERFORMANCES

(obtained with mineral oil with viscosity of 36 cSt at 50°C and integrated electronics)

Maximum operating pressure:		
- P - A - B ports	bar	320
- T port		140
Maximum flow with Δp 10 bar P-T	l/min	30 - 60
Response times	see paragraph 4	
Hysteresis	% of Q max	< 3%
Repeatability	% of Q max	< $\pm 1\%$
Electrical characteristics	see paragraph 5	
Ambient temperature range	°C	-10 / +50
Fluid temperature range	°C	-20 / +80
Fluid viscosity range	cSt	10 ÷ 400
Fluid contamination degree	According to ISO 4406:1999 class 18/16/13	
Recommended viscosity	cSt	25
Mass: single solenoid valve	kg	5,1
double solenoid valve		6,6

HYDRAULIC SYMBOLS (typical)

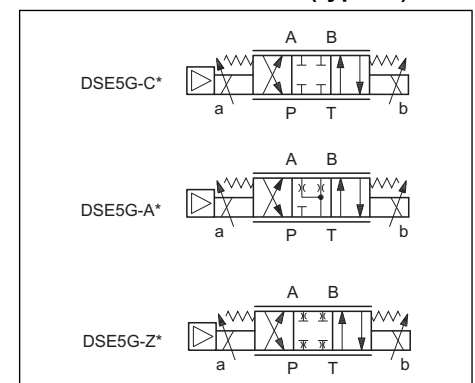

3 - CHARACTERISTIC CURVES (obtained with mineral oil with viscosity of 36 cSt at 50°C and with digital integrated electronics)

Typical flow rate curves at constant Δp related to the reference signal and measured for the available spools. The Δp values are measured between P and T valve ports.

The curves are obtained after linearization in factory of the characteristic curve through the digital amplifier. The linearization of the curve is performed with a constant Δp of 30 bar and by setting the value of flow start at 10% of the reference signal.

NOTE: for the zero overlap spool (Z), please refer to the characteristic curves of C type spool, considering that the starting flow rate value is approx. 150 mV.

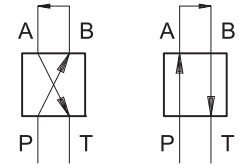

SPOOL TYPE C30

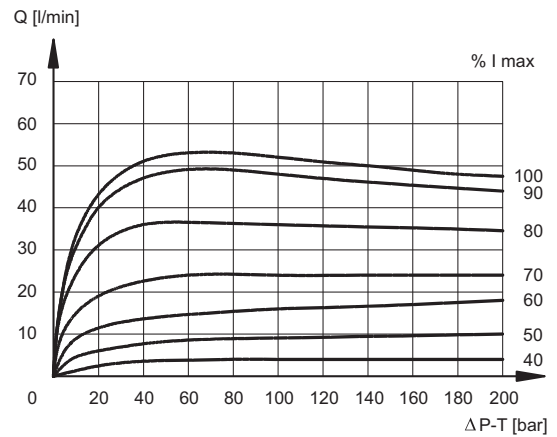
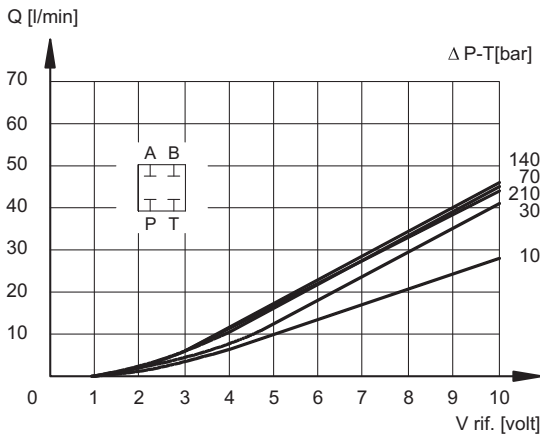

SPOOL TYPE C60

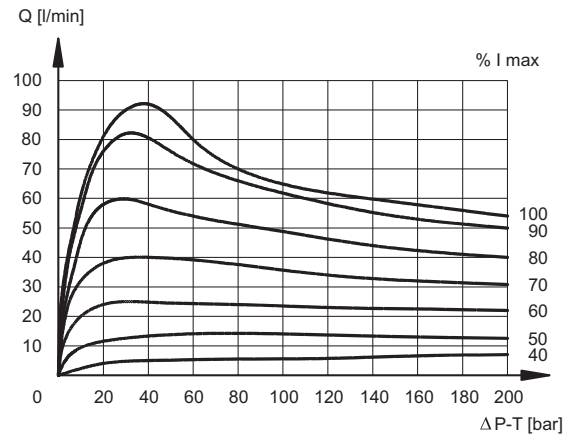
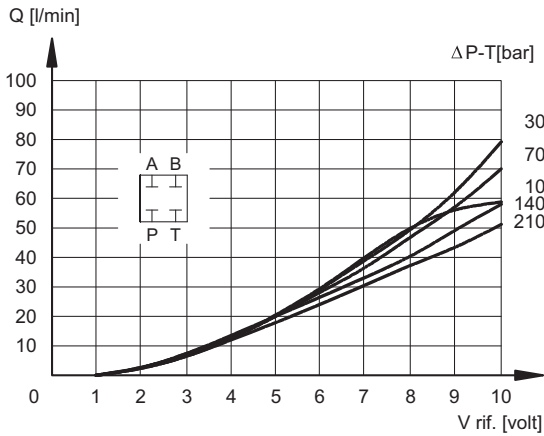

SPOOL TYPE A30

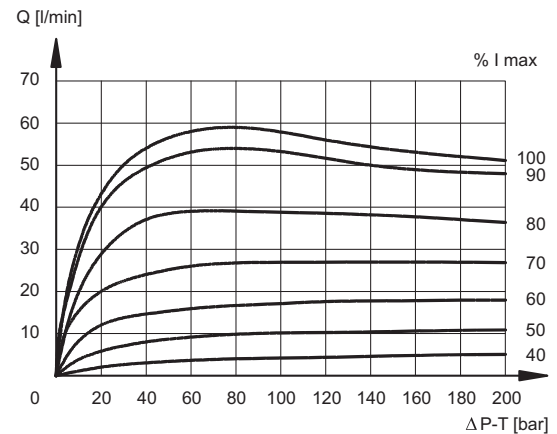
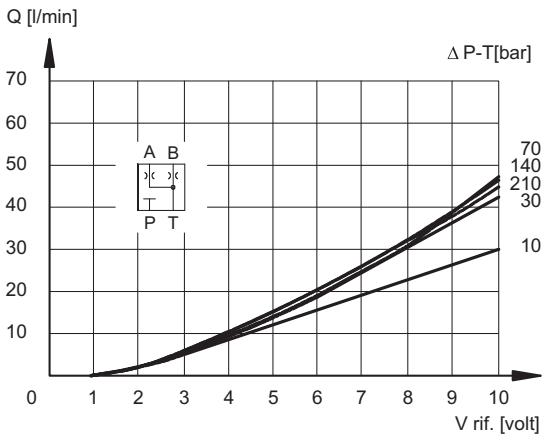



SPOOL TYPE A60

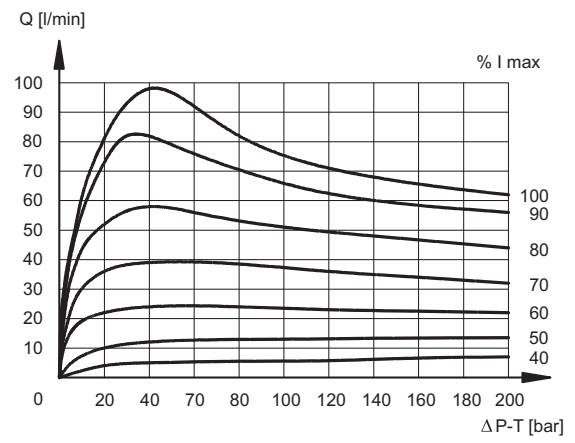
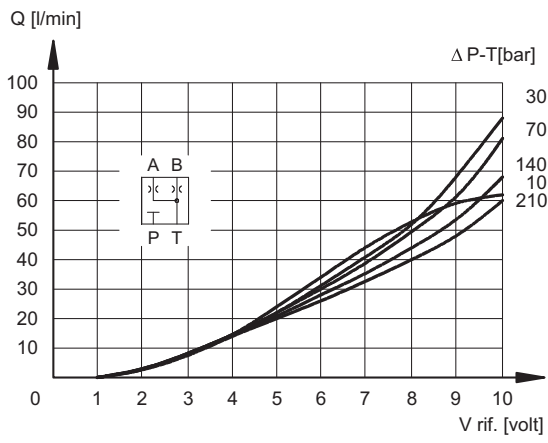

4 - RESPONSE TIMES (obtained with mineral oil with viscosity of 36 cSt at 50°C and with digital integrated electronics)

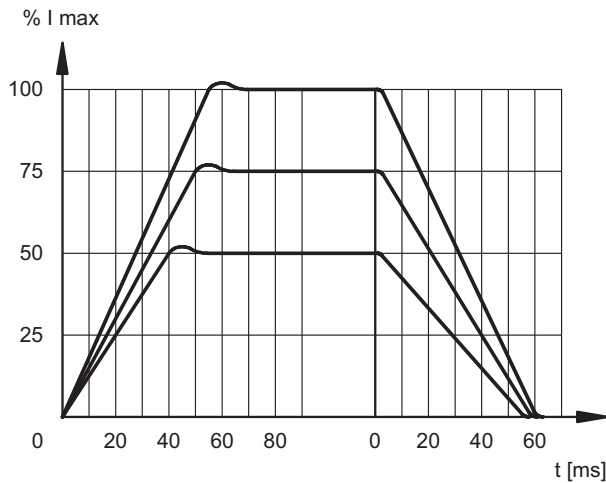

5 - ELECTRICAL CHARACTERISTICS

5.1 - Digital integrated electronics

The proportional valve is controlled by a digital amplifier (driver), which incorporates a microprocessor that controls, via software, all the valve functions, such as:

- continuous converting (0,5 ms) of the voltage reference signal (E0) or of the current reference signal (E1) in a digital value
- generation of up and down ramps (see **NOTE**)
- gains limit (see **NOTE**)
- compensation of the dead band
- linearization of the characteristic curve
- regulation of the current to the solenoid
- dynamic regulation of PWM frequency
- protection of the solenoid outputs against possible short circuits

NOTE: these parameters can be set through the connection to the CAN connector, by means of a personal computer and relevant software (see paragraph 6.3)

The digital driver enables the valve to reach better performance compared to the analogic version, such as:

- reduced hysteresis and improved repeatability
- reduced response times
- linearization of the characteristic curve which is optimised in factory for each valve
- complete interchangeability in case of valve replacement
- possibility to set, via software, the functional parameters
- possibility to interface a CAN-Open network
- possibility to perform a diagnostic program by means of the CAN connection
- high immunity to electromagnetic troubles

5.2 - Functional block diagram

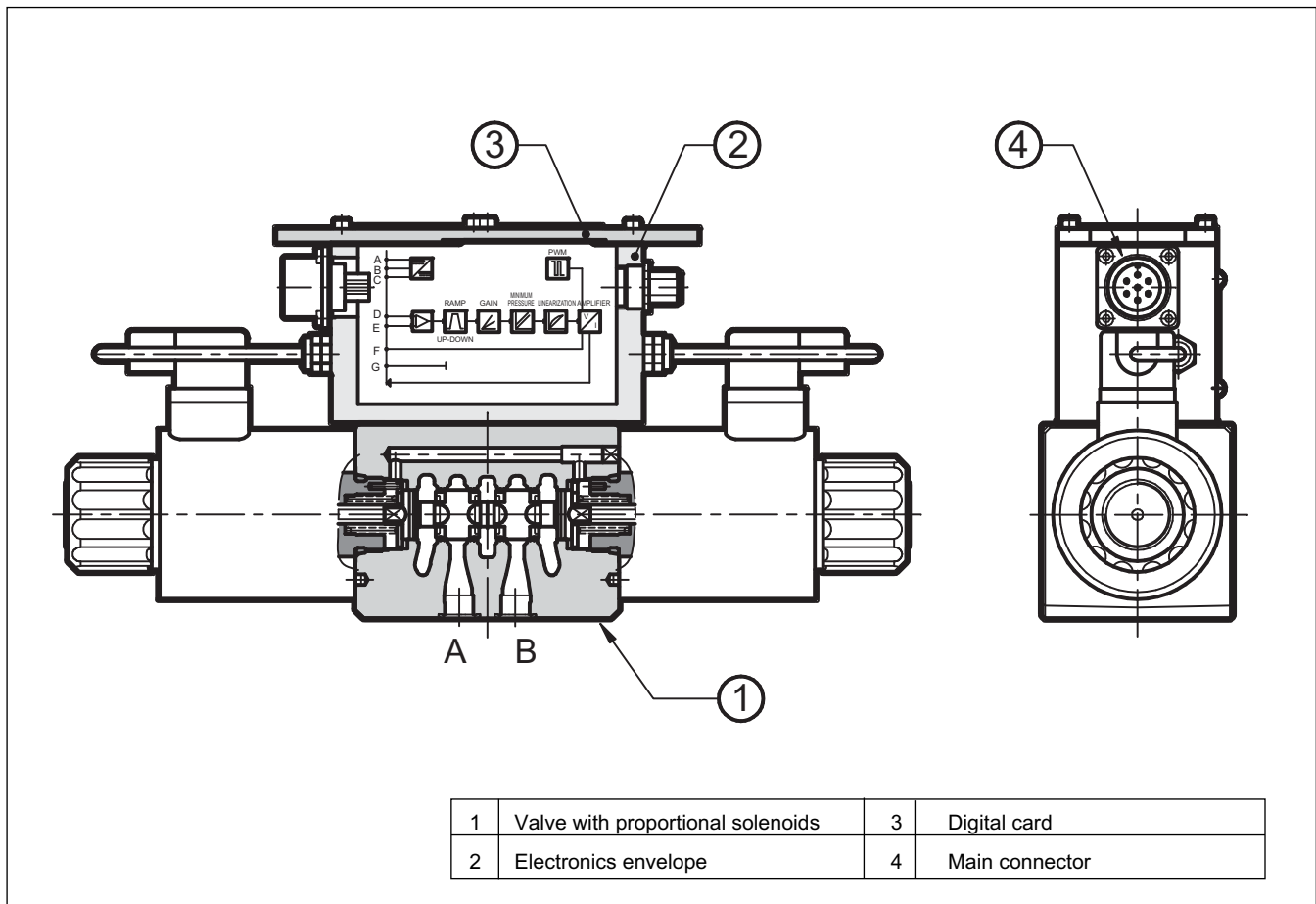

5.3 - Electrical characteristics

NOMINAL VOLTAGE	V DC	24 (from 19 to 35 VDC, ripple max 3 Vpp)
ABSORBED POWER	W	70
MAXIMUM CURRENT	A	2,60
DUTY CYCLE		100%
VOLTAGE SIGNAL (E0)	V DC	±10 (Impedence Ri > 50KΩ)
CURRENT SIGNAL (E1)	mA	4 ÷ 20 (Impedence Ri = 500 Ω)
ALARMS		Overload and electronics overheating
COMMUNICATION		Interface of the optoisolated industrial Field-bus type CAN-Bus ISO 11898
MAIN CONNECTOR		7 - pin MIL-C-5015-G (DIN 43563)
CAN-BUS CONNECTOR		M12-IEC 60947-5-2
ELECTROMAGNETIC COMPATIBILITY ((EMC) emissions immunity	CEI EN 61000-6-4 CEI EN 61000-4-2	According to 2004/108/CE standards
PROTECTION AGAINST ATMOSPHERIC AGENTS :		IP67 (CEI EN 60529 standards)

6 - OPERATING MODALITIES

The digital driver of DSE5G valve may be used with different functions and operating modalities, depending on the requested performances.

6.1 - Standard version with voltage reference signal (E0)

This is the most common version; it makes the valve completely interchangeable with the traditional proportional valves with analog type integrated electronics. The valve has only to be connected as indicated below. This version doesn't allow the setting of the valve parameters, for example the ramps must be performed in the PLC program, as well as the reference signal limit.

Connection scheme (B version - E0)

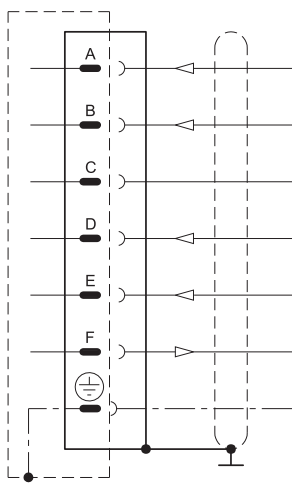

Pin	Values	Function	NOTES
A	24 VDC	Voltage	from 19 to 35 VDC (ripple max 3 Vpp) (see NOTE 3)
B	0 V	Power supply (zero)	0 V
C	----	Not used	----
D	± 10 V	Input rated command	Impedence $R_i > 50 \text{ k}\Omega$ (see NOTE 1)
E	0 V	Input rated command	----
F	± 10 V	Coil current	± 100% I_{MAX} (see NOTE 2)
PE	GND	Protective ground	----

6.2 - Standard version with current reference signal (E1)

This version has characteristics which are similar to the previous one, with the difference that in this case the reference signal is supplied in current 4 - 20 mA. With the 12 mA signal the valve is in central position, with the 20 mA signal the valve performs the configuration P-A and B-T, while with 4 mA the configuration is P-B and A-T. For "SA" single solenoid valves, with reference 20 mA to pin D, the valve full opening is P-B and A-T, while with 4 mA the valve is at rest. This configuration may be modified via software. If the current to solenoid is lower, than the card shows a BREAKDOWN CABLE error. To reset the error switch-off the supply.

Connection scheme (B- version - E1)

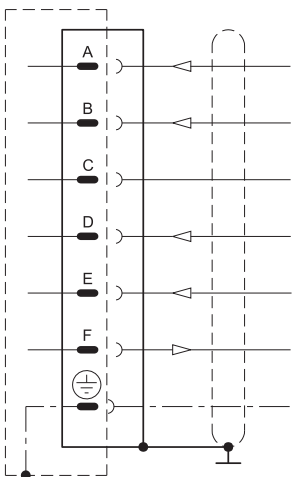

Pin	Values	Function	NOTES
A	24 VDC	Voltage	from 19 to 35 VDC (ripple max 3 Vpp) (see NOTE 3)
B	0 V	Power supply (zero)	0 V
C	----	Not used	----
D	4 ÷ 20 mA	Input signal	Impedence $R_i = 500 \Omega$
E	0 V	Zero reference	----
F	± 10 V	Coil current	± 100% I_{MAX} (see NOTE 2)
PE	GND	Protective ground	----

NOTE 1: Only on version E0 (with voltage reference signal) the input signal is differential type. For double solenoid valves, with positive reference signal connected to pin D, the valve opening is P - A and B - T. With zero reference signal the valve is in central position. For "SA" single solenoid valves, with positive reference to pin D, the valve opening is P-B and A-T. The spool stroke is proportional to $U_D - U_E$.

If only one input signal (single-end) is available, the pin B (0V power supply) and the pin E (0V reference signal) must be connected through a jumper and both connected to GND, electric panel side.

NOTE 2: read the test point pin F in relation to pin B (0V)

NOTE 3: preview on the Pin A (24 VDC) an external fuse for protecting electronics. Fuse characteristics: 5A/50V type fast.

NOTE for the wiring: connections must be made via the 7-pin plug mounted on the amplifier. Recommended cable sizes are 0,75 mm² for cables up to 20m and 1,00 mm² for cables up to 40m, for power supply. The signal cables must be 0,50 mm². A suitable cable would have 7 cores, a separate screen for the signal wires and an overall screen.

6.3 - Version with parameters set by means of CAN connector (version C)

This version allow to set some parameters of the valve connecting a PC to the CAN connector.

To do this, you have to order the interface device for USB port **CANPC-USB/20** (code 3898101002), complete of the configuration software, a communication cable (length 3 mt) and a hardware converter needed to connect the valve to the USB port. The software is Microsoft Windows Xp[®] compliant.

The parameters that can be set are described below:

Maximum current (Gain regulation)

$I_{max A}$ and $I_{max B}$ set the maximum current to the solenoid A corresponding to the positive value of the input reference. With this parameter is possible to reduce the valve flow with the maximum reference.

Default value = 100% of full scale

Range: from 100% to 50% of full scale

PWM Frequency

Sets the PWM frequency, which is the pulsating frequency of the control current. The PWM decrease improves the valve accuracy, decreasing the regulation stability.

The PWM increase improves the regulation stability, causing a higher hysteresis.

Default value = 200 Hz

Range 50 ÷ 500 Hz

Ramps

Increase time of Ramp R1 - solenoid A: sets the current increase time for a variation from 0 to 100% of the input reference from zero to -10V.

Decrease time of Ramp R2 - solenoid A: sets the current decrease time for a variation from 100 to 0% of the input reference from -10V to zero.

Increase time of Ramp R3 - solenoid B: sets the current increase time for a variation from 0 to 100% of the input reference from zero to +10V.

Decrease time of Ramp R4 - solenoid B: sets the current decrease time for a variation from 100 to 0% of the input reference from +10V to zero.

Min time = 0,001 sec

Max time = 40,000 sec

Default time = 0,001 sec.

Diagnostics

Provides several information parameters, such as:

- The electronic driver status (Working or Broken)
- The active regulation
- Input reference
- Current value

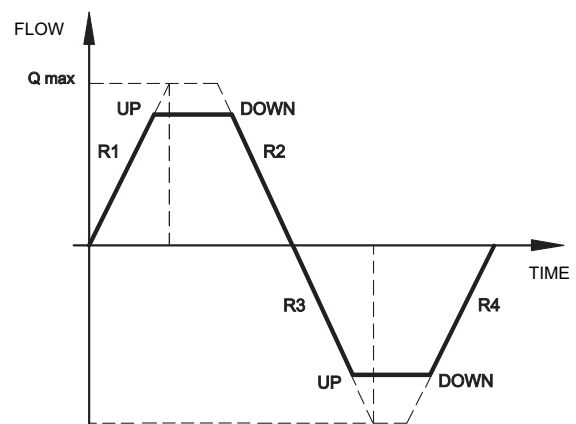
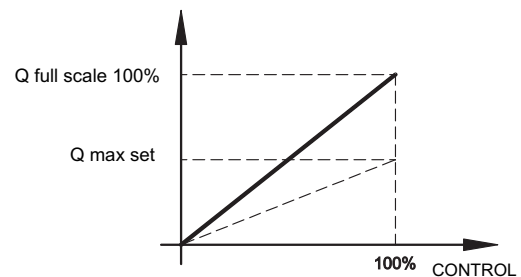

6.4 - Version with CAN-Bus interface (version C)

This version allows the valve piloting through the industrial field bus CAN-Open, according to ISO 11898 standards.

The CAN connector must be connected (see scheme) as a slave node of the CAN-Open bus, while the main connector is wired only for the power supply (pin A and B + earth)

The most important characteristics of a CAN - Open connection are:

- Parameter storage also in PLC
- Parameters setting in real-time (PDO communication)
- On-line valve diagnostics
- Easy wiring with the serial connection
- Communication program according to international standards

For detailed information on the CAN-Open communication software, see cat. 89 800.

CAN connector connection scheme

Pin	Values	Function
1	CAN_SHLD	Monitor
2	CAN +24VDC	BUS + 24 VDC (max 30 mA)
3	CAN 0 DC	BUS 0 VDC
4	CAN_H	BUS line (high signal)
5	CAN_L	BUS line (low signal)

N.B. : insert a 120 Ω resistance on pin 4 and pin 5 of the CAN connector when the valve is the closure knot of the CAN network.

7 - INSTALLATION

DSE5G valves can be installed in any position without impairing correct operation.

Ensure that there is no air in the hydraulic circuit.

Valves are fixed by means of screws or tie rods on a flat surface with planarity and roughness equal to or better than those indicated in the relative symbols. If minimum values are not observed, fluid can easily leak between the valve and support surface.

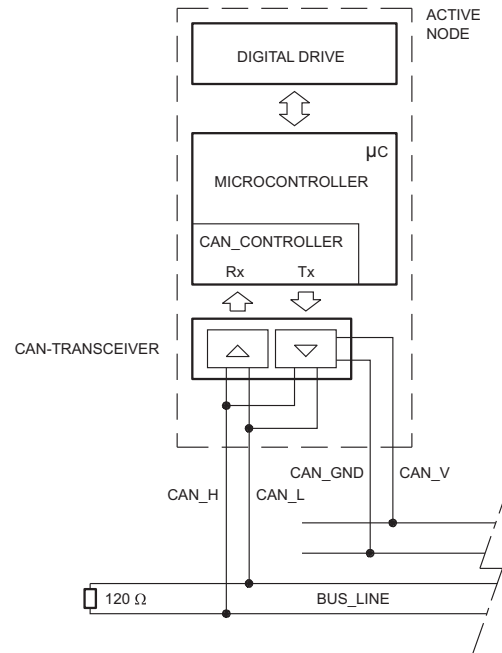

8 - HYDRAULIC FLUIDS

Use mineral oil-based hydraulic fluids HL or HM type, according to ISO 6743-4. For these fluids, use NBR seals (code N).

For fluids HFDR type (phosphate esters) use FPM seals (code V). For the use of other fluid types such as HFA, HFB, HFC, please consult our technical department.

Using fluids at temperatures higher than 80 °C causes a faster degradation of the fluid and of the seals characteristics.

The fluid must be preserved in its physical and chemical characteristics.

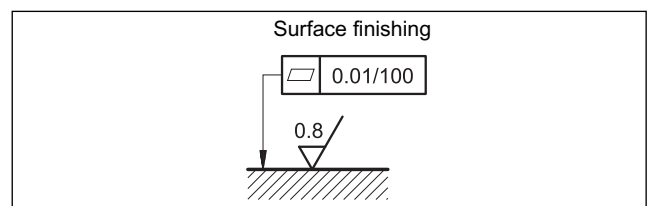

9 - OVERALL AND MOUNTING DIMENSIONS

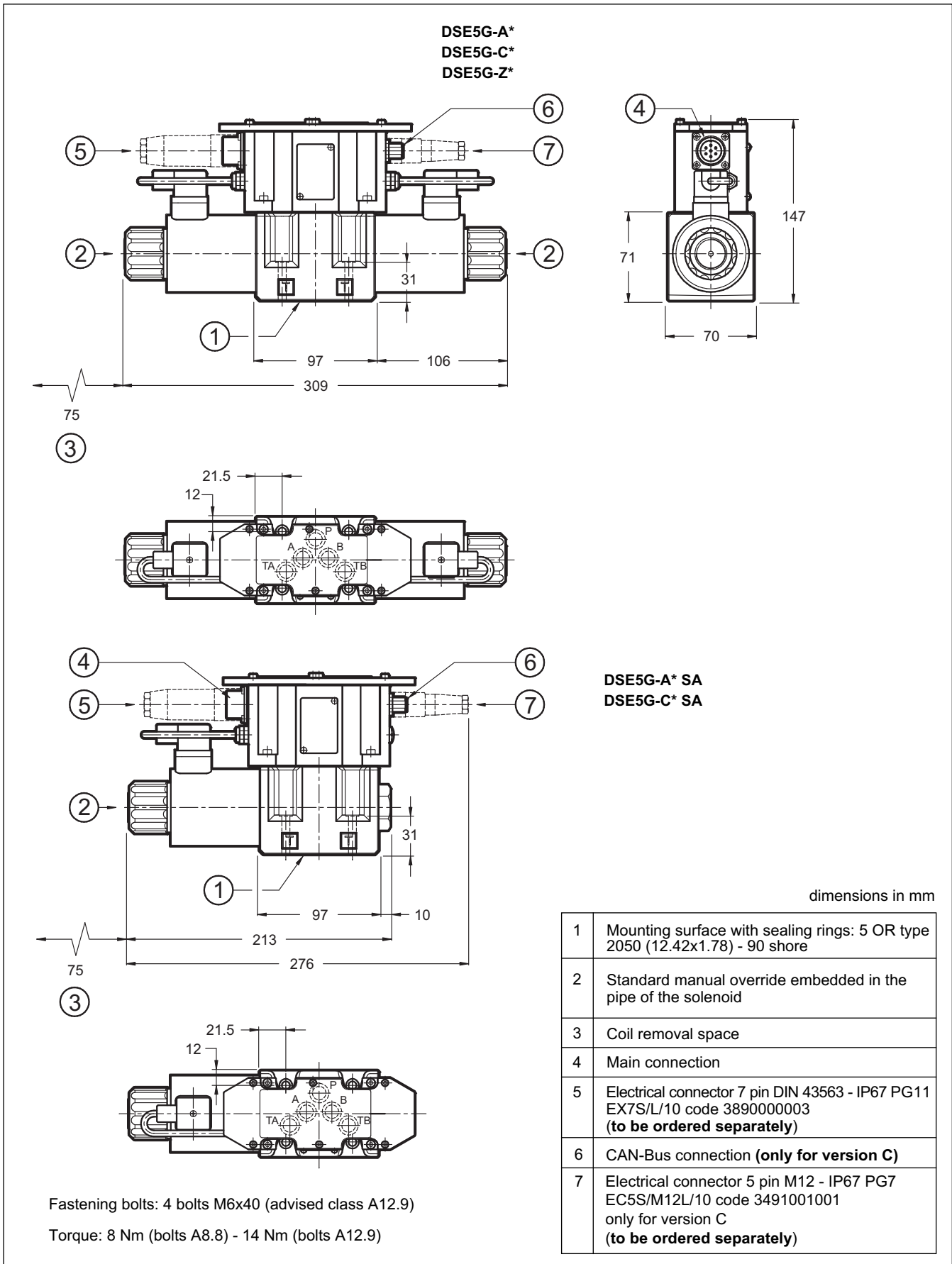



10 - SUBPLATES (See catalogue 51 000)

Type PMD4-AI4G rear ports 1/2" BSP
Type PMD4-AL4G side ports 1/2" BSP



DSE5G

SERIES 10



DIPLOMATIC OLEODINAMICA S.p.A.
20015 PARABIAGO (MI) • Via M. Re Depaolini 24
Tel. +39 0331.895.111
Fax +39 0331.895.339
www.diplomatic.com • e-mail: sales.exp@diplomatic.com

